



FOR THOSE WHO DARE
JOIN THE REPUBLIC OF GAMERS
THE WORLD OF GAMING

ROG STRIX XG258QMG SERIES

USER GUIDE

First Edition

December 2024

Copyright © 2024 ASUSTeK COMPUTER INC. All Rights Reserved.

No part of this manual, including the products and software described in it, may be reproduced, transmitted, transcribed, stored in a retrieval system, or translated into any language in any form or by any means, except documentation kept by the purchaser for backup purposes, without the express written permission of ASUSTeK COMPUTER INC. ("ASUS").

Product warranty or service will not be extended if: (1) the product is repaired, modified or altered, unless such repair, modification or alteration is authorized in writing by ASUS; or (2) the serial number of the product is defaced or missing.

ASUS PROVIDES THIS MANUAL "AS IS" WITHOUT WARRANTY OF ANY KIND, EITHER EXPRESS OR IMPLIED, INCLUDING BUT NOT LIMITED TO THE IMPLIED WARRANTIES OR CONDITIONS OF MERCHANTABILITY OR FITNESS FOR A PARTICULAR PURPOSE. IN NO EVENT SHALL ASUS, ITS DIRECTORS, OFFICERS, EMPLOYEES OR AGENTS BE LIABLE FOR ANY INDIRECT, SPECIAL, INCIDENTAL, OR CONSEQUENTIAL DAMAGES (INCLUDING DAMAGES FOR LOSS OF PROFITS, LOSS OF BUSINESS, LOSS OF USE OR DATA, INTERRUPTION OF BUSINESS AND THE LIKE), EVEN IF ASUS HAS BEEN ADVISED OF THE POSSIBILITY OF SUCH DAMAGES ARISING FROM ANY DEFECT OR ERROR IN THIS MANUAL OR PRODUCT.

SPECIFICATIONS AND INFORMATION CONTAINED IN THIS MANUAL ARE FURNISHED FOR INFORMATIONAL USE ONLY, AND ARE SUBJECT TO CHANGE AT ANY TIME WITHOUT NOTICE, AND SHOULD NOT BE CONSTRUED AS A COMMITMENT BY ASUS. ASUS ASSUMES NO RESPONSIBILITY OR LIABILITY FOR ANY ERRORS OR INACCURACIES THAT MAY APPEAR IN THIS MANUAL, INCLUDING THE PRODUCTS AND SOFTWARE DESCRIBED IN IT.

Products and corporate names appearing in this manual may or may not be registered trademarks or copyrights of their respective companies, and are used only for identification or explanation and to the owners' benefit, without intent to infringe.

Contents

Notices.....	iv
Safety information	v
Care & Cleaning	vi
Takeback Services.....	vii
Chapter 1: Product introduction	
1.1 Welcome!	1-1
1.2 Package contents.....	1-1
1.3 Monitor introduction	1-2
1.3.1 Front/side view	1-2
1.3.2 Back view	1-3
1.3.3 Other Function(s)	1-4
Chapter 2: Setup	
2.1 Assembling the monitor arm/base	2-1
2.2 Cable management	2-1
2.3 Adjusting the monitor.....	2-2
2.4 Detaching the arm (for VESA wall mount).....	2-3
2.5 Connecting the cables.....	2-4
2.6 Turning on the monitor.....	2-4
Chapter 3: General instructions	
3.1 OSD (On-Screen Display) menu	3-1
3.1.1 How to reconfigure.....	3-1
3.1.2 OSD function introduction	3-2
3.2 Aura	3-9
3.3 Specifications summary	3-10
3.4 Outline dimensions	3-12
3.5 Troubleshooting (FAQ).....	3-13
3.6 Supported operating mode	3-14

Notices

Federal Communications Commission Statement

This device complies with Part 15 of the FCC Rules. Operation is subject to the following two conditions:

- This device may not cause harmful interference, and
- This device must accept any interference received including interference that may cause undesired operation.

This equipment has been tested and found to comply with the limits for a Class B digital device, pursuant to Part 15 of the FCC Rules. These limits are designed to provide reasonable protection against harmful interference in a residential installation. This equipment generates, uses and can radiate radio frequency energy and, if not installed and used in accordance with the instructions, may cause harmful interference to radio communications. However, there is no guarantee that interference will not occur in a particular installation. If this equipment does cause harmful interference to radio or television reception, which can be determined by turning the equipment off and on, the user is encouraged to try to correct the interference by one or more of the following measures:

- Reorient or relocate the receiving antenna.
- Increase the separation between the equipment and receiver.
- Connect the equipment into an outlet on a circuit different from that to which the receiver is connected.
- Consult the dealer or an experienced radio/TV technician for help.



The use of shielded cables for connection of the monitor to the graphics card is required to assure compliance with FCC regulations. Changes or modifications to this unit not expressly approved by the party responsible for compliance could void the user's authority to operate this equipment.

Safety information

- Before setting up the monitor, carefully read all the documentation that came with the package.
- To prevent fire or shock hazard, never expose the monitor to rain or moisture.
- Never try to open the monitor cabinet. The dangerous high voltages inside the monitor may result in serious physical injury.
- If the power supply is broken, do not try to fix it by yourself. Contact a qualified service technician or your retailer.
- Before using the product, make sure all cables are correctly connected and the power cables are not damaged. If you detect any damage, contact your dealer immediately.
- Slots and openings on the back or top of the cabinet are provided for ventilation. Do not block these slots. Never place this product near or over a radiator or heat source unless proper ventilation is provided.
- The monitor should be operated only from the type of power source indicated on the label. If you are not sure of the type of power supply to your home, consult your dealer or local power company.
- Use the appropriate power plug which complies with your local power standard.
- Do not overload power strips and extension cords. Overloading can result in fire or electric shock.
- Avoid dust, humidity, and temperature extremes. Do not place the monitor in any area where it may become wet. Place the monitor on a stable surface.
- Unplug the unit during a lightning storm or if it will not be used for a long period of time. This will protect the monitor from damage due to power surges.
- Never push objects or spill liquid of any kind into the slots on the monitor cabinet.
- To ensure satisfactory operation, use the monitor only with UL listed computers which have appropriate configured receptacles marked between 100-240V AC.
- If you encounter technical problems with the monitor, contact a qualified service technician or your retailer.
- Adjustment of the volume control as well as the equalizer to other settings than the center position may increase the ear-/headphones output voltage and therefore the sound pressure level.
- Ensure to connect the power cord to a socket-outlet with earthing connection.
- The supplied power adapter and/or power cable are designed to use with the product only. Do not use with other products.
- The adapter is only used for this monitor, do not use it for other purpose. Your device uses one of the following power supplies:
 - Manufacturer: Delta Electronics Inc., Model: ADP-65GD B

This equipment is not suitable for use in locations where children are likely to be present.

Care & Cleaning

- Before you lift or reposition your monitor, it is better to disconnect the cables and power cord. Follow the correct lifting techniques when positioning the monitor. When lifting or carrying the monitor, grasp the edges of the monitor. Do not lift the display by the stand or the cord.
- Cleaning. Turn your monitor off and unplug the power cord. Clean the monitor surface with a lint-free, non-abrasive cloth. Stubborn stains may be removed with a cloth dampened with mild cleaner.
- Avoid using a cleaner containing alcohol or acetone. Use a cleaner intended for use with the monitor. Never spray cleaner directly on the screen, as it may drip inside the monitor and cause an electric shock.

The following symptoms are normal with the monitor:

- The screen may flicker during the initial use due to the nature of the fluorescent light. Turn off the Power Switch and turn it on again to make sure that the flicker disappears.
- You may find slightly uneven brightness on the screen depending on the desktop pattern you use.
- When the same image is displayed for hours, an afterimage of the previous screen may remain after switching the image. The screen will recover slowly or you can turn off the Power Switch for hours.
- When the screen becomes black or flashes, or cannot work anymore, contact your dealer or service center to fix it. Do not repair the screen by yourself!

Conventions used in this guide



WARNING: Information to prevent injury to yourself when trying to complete a task.



CAUTION: Information to prevent damage to the components when trying to complete a task.



IMPORTANT: Information that you **MUST** follow to complete a task.



NOTE: Tips and additional information to aid in completing a task.

Where to find more information

Refer to the following sources for additional information and for product and software updates.

1. ASUS websites

The ASUS websites worldwide provide updated information on ASUS hardware and software products. Refer to <http://www.asus.com>

2. Optional documentation

Your product package may include optional documentation that may have been added by your dealer. These documents are not part of the standard package.

3. About Flicker

https://www.asus.com/Microsite/display/eye_care_technology/

Takeback Services

ASUS recycling and takeback programs come from our commitment to the highest standards for protecting our environment. We believe in providing solutions for our customers to be able to responsibly recycle our products, batteries and other components as well as the packaging materials.

Please go to <http://csr.asus.com/english/Takeback.htm> for detail recycling information in different region.

1.1 Welcome!

Thank you for purchasing the ROG gaming monitor!

The latest widescreen LCD monitor from ASUS provides a broader, brighter and crystal-clear display, plus a host of features that enhance your viewing experience.

With these features, you can enjoy the convenience and delightful visual experience that the monitor brings to you!

1.2 Package contents

Check your package for the following items:

- ✓ LCD monitor
- ✓ Monitor base
- ✓ Quick start guide
- ✓ Warranty card
- ✓ Power adapter
- ✓ Power cord
- ✓ DisplayPort cable (optional)
- ✓ HDMI cable (optional)
- ✓ USB Type-C cable (optional)
- ✓ ROG sticker
- ✓ ROG pouch



If any of the above items is damaged or missing, contact your retailer immediately.





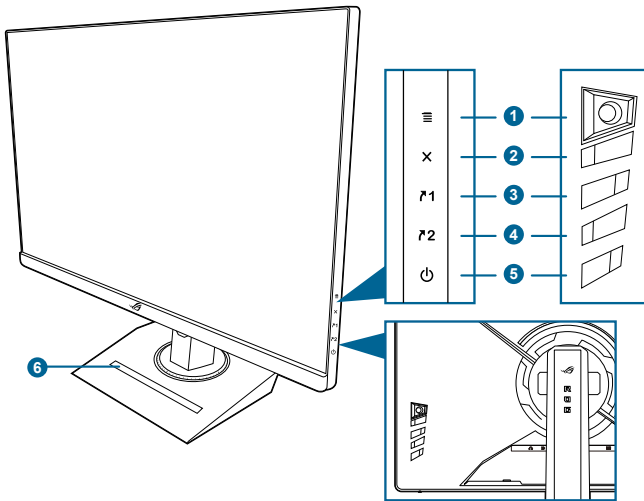

If you need to replace the power cord or the connection cable(s), please contact ASUS customer service.

1.3 Monitor introduction

1.3.1 Front/side view



1.  (5-way) button:
 - Turns on the OSD menu. Enacts the selected OSD menu item.
 - Increases/Decreases values or moves your selection up/down/left/right.
 - Turns on the OSD menu when the monitor enters standby mode or displays the “NO SIGNAL” message.
 - Move and hold the button downward for over 5 seconds to enable/disable the Key Lock function.
2.  button
 - Exits the OSD menu item.
 - Turns on the OSD menu when the monitor enters standby mode or displays the “NO SIGNAL” message.
3.  Shortcut 1 button:
 - Default: GamePlus.
 - To change the shortcut function, go to the **MyFavorite > Shortcut > Shortcut 1** menu.
 - Turns on the OSD menu when the monitor enters standby mode or displays the “NO SIGNAL” message.
4.  Shortcut 2 button:

- Default: GameVisual.
 - To change the shortcut function, go to the **MyFavorite > Shortcut > Shortcut 2** menu.
 - Turns on the OSD menu when the monitor enters standby mode or displays the “NO SIGNAL“ message.
5.  Power button/power indicator
- Turns the monitor on/off.
 - The color definition of the power indicator is as the below table.

Status	Description
White	ON
Amber	Standby mode/No signal
OFF	OFF

6. Phone holder
- The size of the phone holder is 11.28 x 169.97 mm. Make sure your device fits into the groove.

1.3.2 Back view

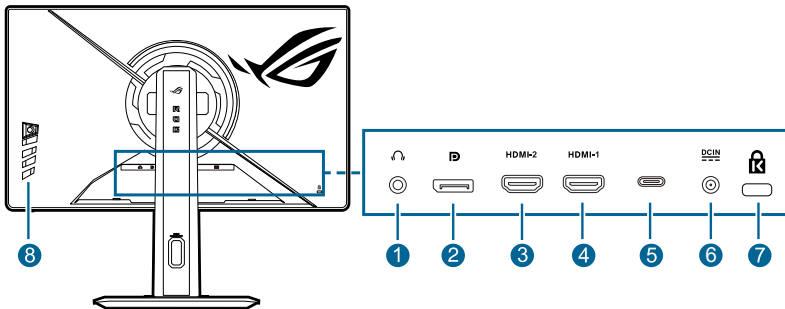

1. **Earphone jack.** This port is only available when an HDMI/DisplayPort cable is connected.
2. **DisplayPort.** This port is for connection with a DisplayPort compatible device.
3. **HDMI-2 port.** This port is for connection with an HDMI compatible device.
4. **HDMI-1 port.** This port is for connection with an HDMI compatible device.
5. This port is for service and **Aura Sync** only. (USB Type-C)
6. **DC-IN port.** This port connects the power adapter.

7. Kensington lock slot.
8. Control buttons.

1.3.3 Other Function(s)

- Tripod socket atop

1/4-inch tripod socket on the monitor stand allows you to mount a camera, audio equipment or additional display.

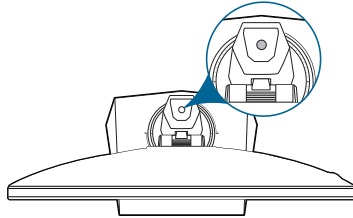

- HDR

The monitor supports HDR format.



When displaying HDR content, the following function(s) are not available: **ELMB, ELMB SYNC, ELMB Setup, GameVisual, Shadow Boost, Brightness, Contrast, ASCR, Blue Light Filter, Display Color Space, Color Temp., Saturation, Six-axis Saturation, Gamma, Power Saving Mode, VividPixel.**

2.1 Assembling the monitor arm/base

1. Insert the base into the arm.
2. Fix the base to the arm by fastening the bundled screw.

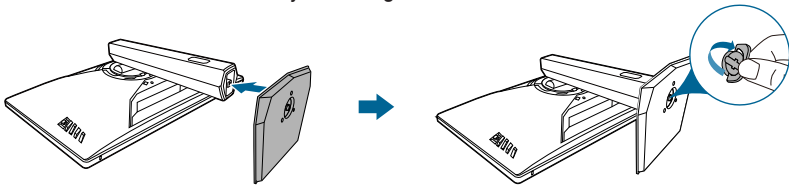

We recommend that you cover the table surface with soft cloth to prevent damage to the monitor.



Base screw size: M6 x 15 mm.

2.2 Cable management

You can organize the cables with the help of the cable management hole.

- **Arranging the cables**

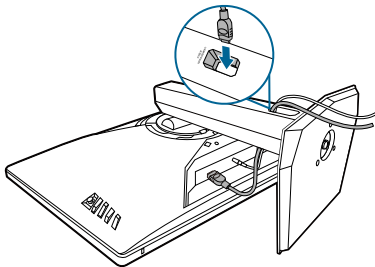

- **Using the input/output port cover:** the cover can be attached or detached.

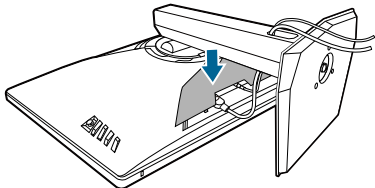

2.3 Adjusting the monitor

- For optimal viewing, we recommend that you look at the full face of the monitor, then adjust the monitor to the angle that is most comfortable for you.
- Hold the stand to prevent the monitor from falling when you change its angle.
- The recommended adjusting angle is $+20^{\circ}$ to -5° (for tilt)/ $+45^{\circ}$ to -45° (for swiveling)/120 mm (for height adjustment)/ $\pm 90^{\circ}$ (for portrait view).

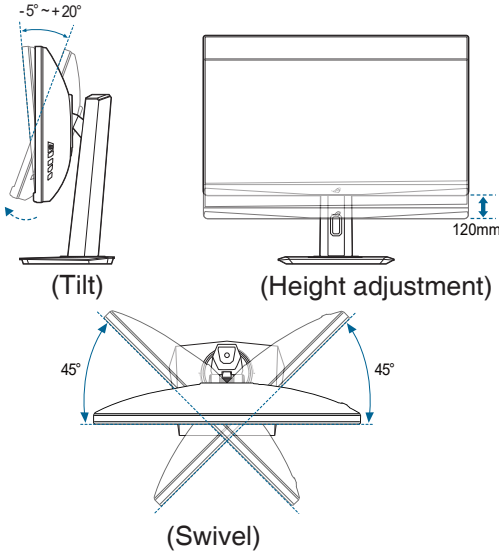

Pivoting the monitor

1. Lift the monitor to the highest position.
2. Tilt the monitor to its maximum angle.
3. Pivot the monitor clockwise or counterclockwise to the angle you need.

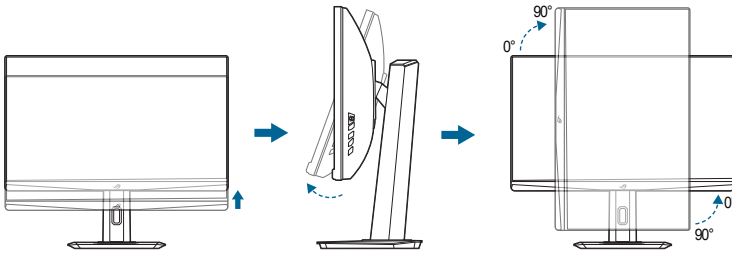

It is normal that the monitor slightly shakes while you adjust the viewing angle.

2.4 Detaching the arm (for VESA wall mount)

The detachable arm of this monitor is specially designed for VESA wall mount.

To detach the arm:

1. Have the front of the monitor face down on a table.
2. Remove the covers on where the monitor and the arm meet.
3. Loosen the four screws on the back of the monitor and remove the arm/ base.

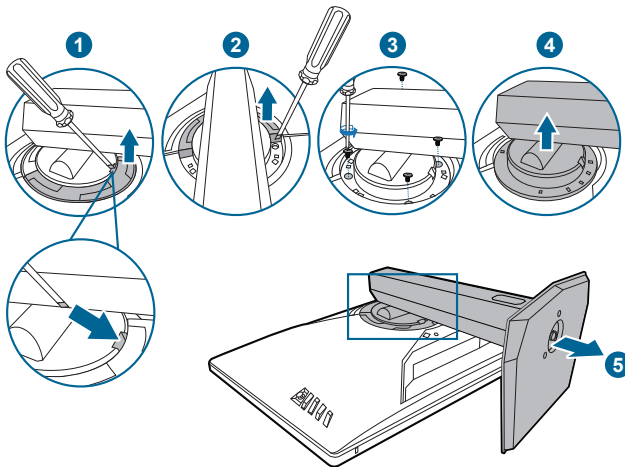

We recommend that you cover the table surface with soft cloth to prevent damage to the monitor.



- The VESA wall mount kit (100 x 100 mm) is purchased separately.
- Use only the UL Listed Wall Mount Bracket with minimum weight/load 22.7kg (Screw size: M4 x 10 mm)

2.5 Connecting the cables

Connect the cables as the following instructions:

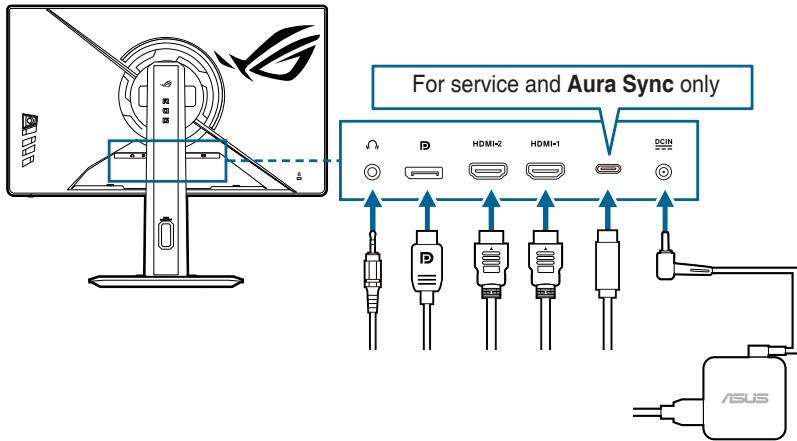

- **To connect the power cord:**
 - a. Connect the power adapter securely to the monitor's DC input.
 - b. Connect one end of the power cord to the power adapter and the other end to a power outlet.
- **To connect the HDMI/DisplayPort cable:**
 - a. Plug one end of the HDMI/DisplayPort cable to the monitor's HDMI/DisplayPort jack.
 - b. Connect the other end of the HDMI/DisplayPort cable to your device's HDMI/DisplayPort jack.





When these cables are connected, you can choose the desired signal from the Input Select item in the OSD menu.



If you need to replace the power cord or the connection cable(s), please contact ASUS customer service.

- **To use the earphone:** connect the audio cable to the monitor's earphone jack.







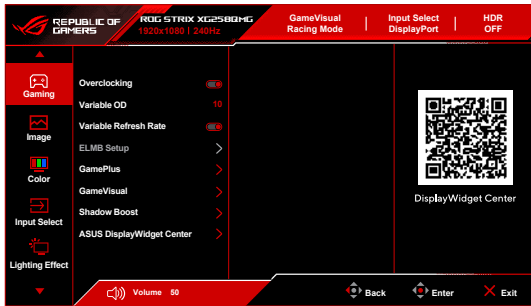

2.6 Turning on the monitor

Press the power button . See page 1-3 for the location of the power button. The power indicator  lights up in white to show that the monitor is ON.

3.1 OSD (On-Screen Display) menu

3.1.1 How to reconfigure





1. Press the  button to activate the OSD menu.
 2. Move the  button up/down to navigate through the functions. Highlight the desired function and press the  button to activate it. If the function selected has a sub-menu, move the  button up/down again to navigate through the sub-menu functions. Highlight the desired sub-menu function and press the  button or move the  button right to activate it.
 3. Move the  button up/down to change the settings of the selected function.
 4. To exit and save the OSD menu, press the  button or move the  left repeatedly until the OSD menu disappears. To adjust other functions, repeat steps 1-3.
- **ASUS DisplayWidget Center:** Displays a QR code for you to access the information about ASUS DisplayWidget Center.

3.1.2 OSD function introduction

1. Gaming



- **Overclocking:** Allows you to select a maximum refresh rate of 280Hz (Only for DisplayPort input). After selecting, press the  () button to activate the setting.



Overclocking may cause screen flickering. To reduce such effects, disconnect the DisplayPort cable and turn off **Overclocking**. For supported GPUs, minimum PC system and driver requirements, please contact the GPU manufacturers.

- **Variable OD:** Improves the gray level response time of the LCD panel.
- **Variable Refresh Rate:** Allows an Variable Refresh Rate supported* graphics source to dynamically adjust display refresh rate based on typical content frame rates for power efficient, virtually stutter free and low-latency display update.



- When this function is activated, the following function(s) are not available: **ELMB**.
- ***Variable Refresh Rate** can only be activated within 48Hz~240Hz for HDMI, 48Hz~280Hz for DisplayPort.
- *For supported GPUs, minimum PC system and driver requirements, please contact the GPU manufacturers.

- **ELMB Setup:**

- * **ELMB:** ELMB can only be activated when **Variable Refresh Rate** is **OFF** and the refresh rate is 120Hz, 144Hz, 240Hz, 260Hz (DisplayPort only), or 280Hz (DisplayPort only). This function eliminates screen tearing, reduces ghosting and motion blur when playing games. The function includes 5-level clarity and position adjustment.



When **ELMB**, **Clarity Level** and **Clarity Position** are activated, the following function(s) are not available: **Variable Refresh Rate**, **ELMB SYNC**, **Brightness**, **Aspect Control**, **ASCR**, **Blue Light Filter**, **Variable OD**, **HDR Setting**.



- * **ELMB SYNC:** Allows you to turn on the function when **Variable Refresh Rate** is **ON**. This function eliminates screen tearing, reduces ghosting and motion blur when playing games.

When this function is activated, the following function(s) are not available:
Brightness, Blue Light Filter, ASCR, Aspect Control, ELMB, HDR Setting.

- **GamePlus:** The GamePlus function provides a toolkit and creates a better gaming environment for users when playing different types of games.
 - * **FPS Counter:** The FPS (frames per second) counter lets you know how smooth the game is running.
 - * **Crosshair:** The crosshair overlays with 6 different crosshair options letting you choose the one that best suits the game you're playing.
 - * **Timer:** You can position the timer on the upper left corner of the display so you can keep track of the gaming time.
 - * **Stopwatch:** You can position the stopwatch on the upper left corner of the display so you can keep track of the gaming time.
 - * **Display Alignment:** **Display Alignment** displays alignment lines on 4 sides of the screen, serving as an easy and handy tool for you to line up multiple monitors perfectly.
- **GameVisual:** The GameVisual function helps you select among different picture modes in a convenient way.
 - * **Scenery Mode:** This is the best choice for scenery photo displaying with GameVisual™ Video intelligence Technology.
 - * **Racing Mode:** This is the best choice for racing game playing with GameVisual™ Video intelligence Technology.
 - * **Cinema Mode:** This is the best choice for movie watching with GameVisual™ Video intelligence Technology.
 - * **RTS/RPG Mode:** This is the best choice for Real-Time Strategy (RTS)/ Role-Playing Game (RPG) playing with GameVisual™ Video intelligence Technology.
 - * **FPS Mode:** This is the best choice for First Person Shooter game playing with GameVisual™ Video intelligence Technology.
 - * **sRGB Mode:** This is the best choice for viewing photos and graphics from PCs.
 - * **MOBA Mode:** This is the best choice for multiplayer online battle arena game playing with GameVisual™ Video intelligence Technology.
 - * **Night Vision:** This is the best choice for dark scenery playing with GameVisual™ Video intelligence Technology.
 - * **User Mode:** More items are adjustable for color adjustments.



- When this function is activated, the following function(s) are not available: **HDR**.
- In the **sRGB Mode**, the following function(s) are not user-configurable: **Shadow Boost, Contrast, ASCR, Blue Light Filter, Display Color Space, Color Temp., Saturation, Six-axis Saturation, Gamma, .**
- In the **MOBA Mode**, the following function(s) are not user-configurable: **Shadow Boost, VividPixel, Saturation, Six-axis Saturation.**
- In the **Night Vision**, the following function(s) are not user-configurable: **Saturation, Six-axis Saturation.**

- **Shadow Boost:** Dark color enhancement adjusts monitor gamma curve to enrich the dark tones in an image, making dark scenes and objects much easier to be seen.



This function is only available in **Scenery Mode, Racing Mode, Cinema Mode, RTS/RPG Mode, FPS Mode, Night Vision** or **User Mode**.

- **ASUS DisplayWidget Center:** Displays a QR code for you to access the information about ASUS DisplayWidget Center.

2. Image



- **Brightness:** The adjusting range is from 0 to 100.
- **Contrast:** The adjusting range is from 0 to 100.
- **HDR Setting:** Contains 3 HDR modes, including **Gaming HDR, Cinema HDR** and **Console HDR**. The HDR brightness can be adjusted when the **Adjustable HDR** function is enabled.



HDR PQ curve will be affected when **Adjustable HDR** is **ON** under HDR mode.



When displaying HDR content, the following function(s) are not available: **ELMB, ELMB SYNC, ELMB Setup, GameVisual, Shadow Boost, Brightness, Contrast, ASCR, Blue Light Filter, Display Color Space, Color Temp., Saturation, Six-axis Saturation, Gamma, Power Saving Mode.**

- **ASCR:** Turns on/off the ASCR (ASUS Smart Contrast Ratio) function.



When this function is activated, the following function(s) will be disabled: **ELMB**, **ELMB SYNC**.

- **Aspect Control:** Adjust the aspect ratio to **16:9** or **Square** to enjoy different gaming scenario.
 - * **16:9:** Simply choose **Fill Up** under **Full** for better FPS gaming size; or you can choose **Pixel by Pixel** under Windows Display setting.
 - * **Square:** Provides multiple square aspect ratio choices with different screen sizes, including **Full**, **Equivalent** and **Pixel by Pixel**.



When this function is activated, the following function(s) will be disabled: **ELMB**, **ELMB SYNC**. Additionally, latency may occur when **Variable Refresh Rate** is activated.

- **Blue Light Filter:**
 - * **OFF:** No change.
 - * **Level 1~Level 4:** The higher the level, the less blue light is scattered. When **Blue Light Filter** is activated, the default settings of **Racing Mode** will be automatically imported. Between **Level 1** to **Level 3**, the Brightness function is user-configurable. **Level 4** is an optimized setting. It is in compliance with TUV Low Blue Light Certification. The Brightness function is not user-configurable.



When this function is activated, the following function(s) will be disabled: **ELMB**, **ELMB SYNC**.



- Please refer to the following to alleviate eye strains:
 - Users should take some time away from the display if working for long hours. It is advised to take short breaks (at least 5 mins) after around 1 hour of continuous working at the computer. Taking short and frequent breaks is more effective than a single longer break.
 - To minimize eye strain and dryness in your eyes, you should rest the eye periodically by focusing on objects that are far away.
 - Eye exercises can help to reduce eye strain. Repeat these exercises often. If eye strain continues, please consult a physician. Eye exercises: (1) Repeating look up and down (2) Slowly roll your eyes (3) Move your eyes diagonally.
 - High energy blue light may lead to eye strain and AMD (Age-Related Macular Degeneration). Blue light Filter reduces 70% (max.) of harmful blue light to avoid CVS (Computer Vision Syndrome).
-
- **VividPixel:** This function enhances the outline of the displayed picture and generates high-quality images on screen.

3. Color

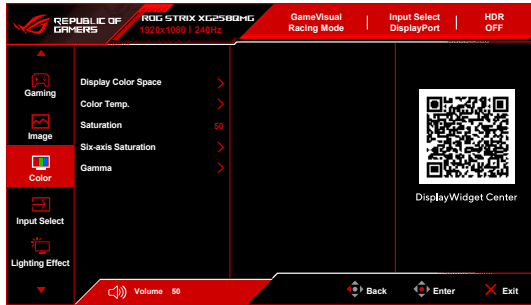

- **Display Color Space:** Selects the color space for the monitor color output.
- **Color Temp.:** Contains 8 modes including 4000K, 5000K, 6500K, 7500K, 8200K, 9300K, 10000K and User.
- **Saturation:** The adjusting range is from 0 to 100.
- **Six-axis Saturation:** Adjusts the saturation for R, G, B, C, M, Y.
- **Gamma:** Allows you to set the color mode to 1.8, 2.0, 2.2, 2.4 or 2.6.

4. Input Select

In this function, you can select your desired input source.

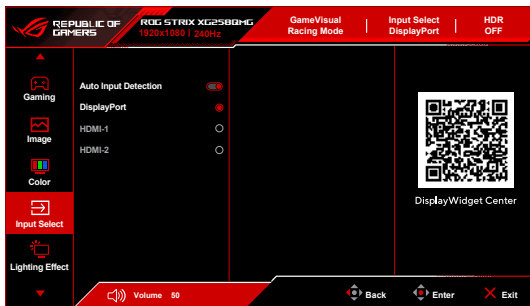

- **Auto Input Detection:** When enabled, the system will automatically select the latest inserted I/O port.
- **DisplayPort/HDMI-1/HDMI-2:** Manually selects the input source.

5. Lighting Effect

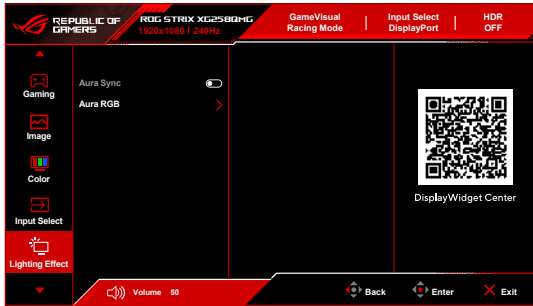

- **Aura Sync:** Allows you to turn on or off the Aura Sync function that synchronizes the Aura RGB light effect among all supported devices.



The following function(s) will be disabled when this function turns on:
Aura RGB.

- **Aura RGB:** There are several living colors can be chosen: **OFF, Rainbow, Color Cycle, Static, Breathing, Strobing.** You can manually change the **R/G/B/C/M/Y** color for **Static, Breathing, and Strobing** modes.



This function is not available when **Aura Sync** is enabled.

6. MyFavorite

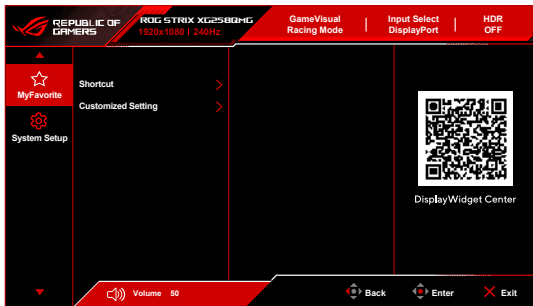

- **Shortcut:**
 - * **Shortcut 1/Shortcut 2:** Sets the shortcut functions for shortcut buttons.



When a certain function is selected or activated, your shortcut button may not support. Available function choices: **GamePlus, GameVisual, Variable OD, Brightness, Mute, Shadow Boost, Contrast, Input Select, HDR Setting, Blue Light Filter, Color Temp., Volume (Earphone Out), Customized Setting-1, Customized Setting-2.**

- **Customized Setting:**
 - * **Setting 1/Setting 2:** Loads/Saves all settings on the monitor.

7. System Setup

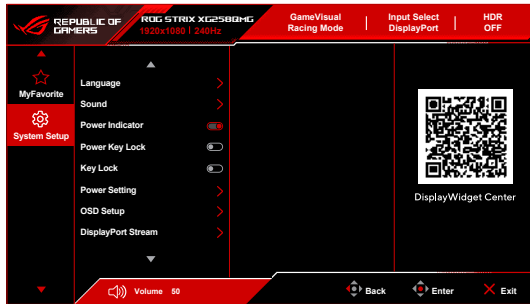

- **Language:** There are 23 languages for your selection, including English, French, German, Italian, Spanish, Dutch, Portuguese, Russian, Czech, Croatian, Polish, Romanian, Hungarian, Turkish, Simplified Chinese, Traditional Chinese, Japanese, Korean, Thai, Indonesian, Persian, Ukrainian and Vietnamese.
- **Sound:** Sets the sound related settings from this menu.
 - * **Volume (Earphone Out):** The adjusting range is from 0 to 100.
 - * **Mute:** Toggles the monitor sound between on and off.
- **Power Indicator:** Turns the power LED indicator on/off.
- **Power Key Lock:** Enables or disables the power key.
- **Key Lock:** To disable all function keys. Move and hold the  (5-way) button downward for over 5 seconds to cancel the key lock function.
- **Power Setting:**
 - * **Performance Mode:** Performance Mode setting may result in higher power consumption.
 - * **Power Saving Mode:** Power Saving Mode may cause limited luminance performance. Disable the HDR function before activating the **Power Saving Mode**.
- **OSD Setup:**
 - * **OSD Position:** Adjusts the horizontal position (H-Position)/the vertical position (V-Position) of the OSD.
 - * **OSD Timeout:** Adjusts the OSD timeout from 10 to 120 seconds.
 - * **Transparency:** Adjusts the OSD background from opaque to transparent.
 - * **DDC/CI:** Enables or disables the **DDC/CI** function. When **Variable Refresh Rate** is on, the **DDC/CI** function will automatically turn on.
- **DisplayPort Stream:** Compatibility with graphic card. Select **DisplayPort 1.2** or **DisplayPort 1.4** by graphic card DP version.
- **Information:** Shows the monitor information.
- **All Reset:** Selecting **Yes** allows you to restore the default settings.

3.2 Aura

Armoury Crate is a software program that controls the colorful LEDs on supported devices, such as monitors, motherboards, graphic cards, desktop PCs, etc. Aura allows you to adjust the color of the RGB LEDs on these devices and select different light effects. You can also correct or adjust the color of the LEDs by calibrating them.

To activate Aura:

1. Turn ON the **Aura Sync** function in the OSD menu.
2. Connect the USB Type-C port of the monitor to the USB port of your computer.
3. Install Armoury Crate and then restart the computer.
4. Execute Armoury Crate.

Below is the overview of this program.

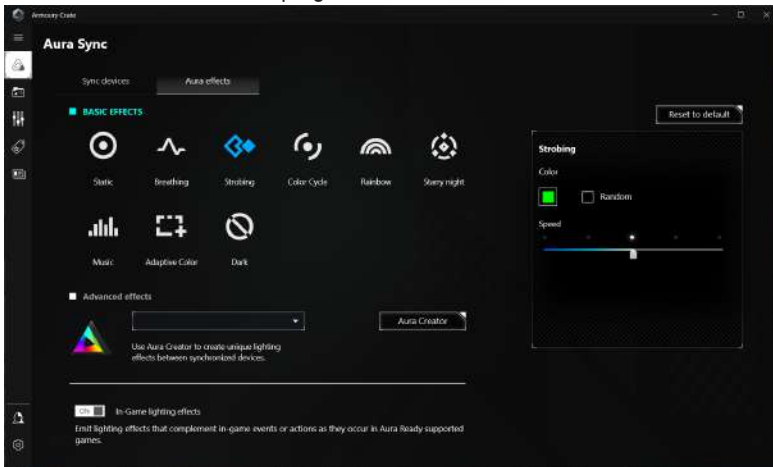

- If the USB Type-C connection between the monitor and computer is disconnected, to resume the Aura function, you need to re-connect the USB Type-C port of the monitor to the computer and then restart the computer.
- Visit https://rog.asus.com/innovation/armoury_crate/ for more details.

3.3 Specifications summary

Panel type	TFT LCD
Panel size	24.5"W (62.2 cm) wide screen
Max. resolution	1920 x 1080
Pixel pitch	0.2829 mm x 0.2802 mm
Brightness (Typ.)	400 cd/m ²
Contrast ratio (Typ.)	1000:1
Viewing angle(H/V) CR>10	178°/178°
Display colors	16.7 M
Response time	0.2 ms (GTG, min.) ; 1 ms (GTG)
Color temperature selection	8 color temperatures
Analog input	No
Digital input	DisplayPort v1.4 x 1, HDMI v2.0 x 2
Earphone jack	Yes
Audio input	No
Speaker (Built-in)	No
USB 3.2 Gen 1 port	No
Colors	Black
Power LED	White (On)/Amber (Standby)
Tilt	+20° ~ -5°
Pivot	+/-90°
Swivel	+45° ~ -45°
Height adjustment	120 mm
VESA wall mount	100 x 100 mm
Kensington lock	Yes
Voltage rating	AC: 100~240V DC: 19 V, 3.42 A (AC adapter)
Power consumption	Power On: < 20 W**, Standby: < 0.5 W, Power Off: < 0.3 W
Temperature (Operating)	0°C~40°C
Temperature (Non-operating)	-20°C~+60°C
Dimensions (W x H x D)	55.7 x 33.0 x 8.9 cm (without stand) 55.7 x 37.2 x 21.9 cm (with stand, lowest) 55.7 x 49.2 x 21.9 cm (with stand, highest) 71.7 x 41.4 x 23.6 cm (package)
Weight (Esti.)	3.4 kg (without stand); 6.05 kg (Net); 8.34 kg (Gross)
Multi-languages	23 languages (English, French, German, Italian, Spanish, Dutch, Portuguese, Russian, Czech, Croatian, Polish, Romanian, Hungarian, Turkish, Simplified Chinese, Traditional Chinese, Japanese, Korean, Thai, Indonesian, Persian, Ukrainian, Vietnamese)

Accessories	Quick start guide, warranty card, power adapter, power cord, DisplayPort cable (optional), HDMI cable (optional), USB Type-C cable (optional), ROG sticker, ROG pouch
Compliance and standards	CB, CCC, China Energy Label, VCCI, PSE, PC Recycle, J-MOSS, HDMI, DP, VESA Adaptive Sync, VESA HDR400, WHQL (WIN 10, 11), TUV Flicker free, TUV Low Blue Light, FreeSync premium

***Specifications are subject to change without notice.**

****Measuring a screen brightness of 200 nits without audio/USB/Card reader connection.**

3.4 Outline dimensions

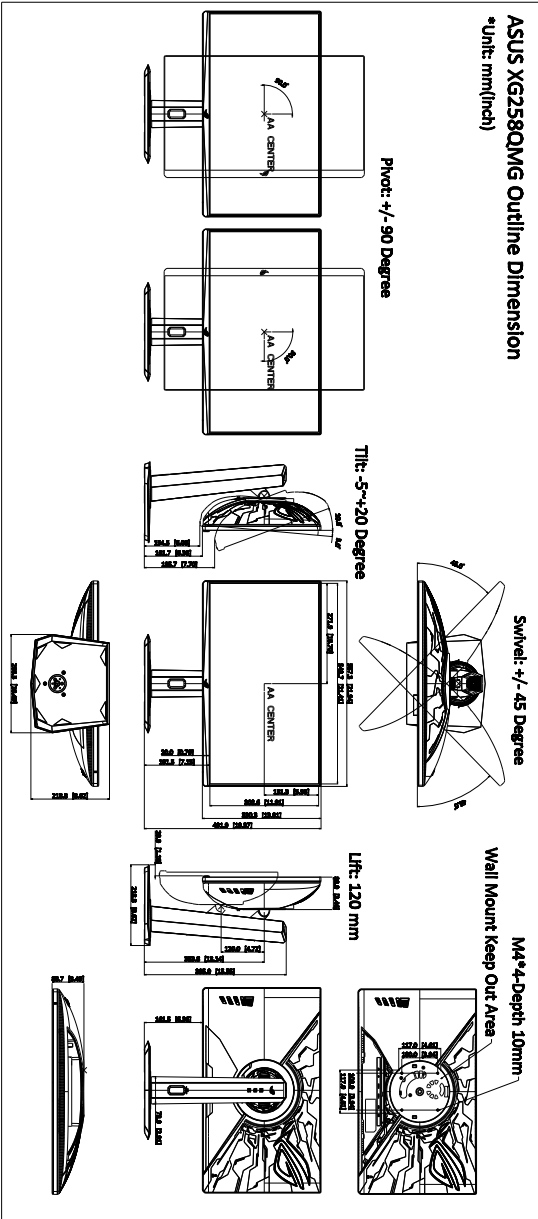

3.5 Troubleshooting (FAQ)

Problem	Possible Solution
Power LED is not ON	<ul style="list-style-type: none">• Press the  button to check if the monitor is in the ON mode.• Check if the power cord is properly connected to the monitor and the power outlet.
The power LED lights white and there is no screen image	<ul style="list-style-type: none">• Check if the monitor and the computer are in the ON mode.• Make sure the signal cable is properly connected the monitor and the computer.• Inspect the signal cable and make sure none of the pins are bent.• Connect the computer with another available monitor to check if the computer is properly working.
Screen image is too light or dark	<ul style="list-style-type: none">• Adjust the Contrast and Brightness settings via OSD.
Screen image bounces or a wave pattern is present in the image	<ul style="list-style-type: none">• Make sure the signal cable is properly connected to the monitor and the computer.• Move electrical devices that may cause electrical interference.
Screen image has color defects (white does not look white)	<ul style="list-style-type: none">• Inspect the signal cable and make sure that none of the pins are bent.• Perform All Reset via OSD.• Adjust the R/G/B color settings or select the Color Temperature via OSD.
Brightness decreases after displaying HDR content for a period of time	<ul style="list-style-type: none">• Turn off the monitor by pressing the power button and then turn on the monitor.• Turn off the monitor by disconnecting the power cord and then turn on the monitor.• Reactivate the HDR function on your device.

3.6 Supported operating mode

- **Native timings**

Resolution	DisplayPort Refresh rate	HDMI Refresh rate
640 x 480	60Hz	60Hz
640 x 480	75Hz	75Hz
800 x 600	60Hz	60Hz
800 x 600	75Hz	75Hz
1024 x 768	60Hz	60Hz
1024 x 768	75Hz	75Hz
1280 x 960	60Hz	60Hz
1280 x 1024	60Hz	60Hz
1280 x 720	60Hz	60Hz
1600 x 900	60Hz	60Hz
1920 x 1080	60Hz	60Hz
1920 x 1080	144Hz	144Hz
1920 x 1080	240Hz	240Hz
1920 x 1080	260Hz*	-
1920 x 1080	280Hz*	-

*Only supported when Overclocking is activated.

- **For Square timings**

Resolution	DisplayPort Refresh rate	HDMI Refresh rate
640 x 480	60Hz	60Hz
640 x 480	75Hz	75Hz
800 x 600	60Hz	60Hz
800 x 600	75Hz	75Hz
1024 x 768	60Hz	60Hz
1024 x 768	75Hz	75Hz
1280 x 960	60Hz	60Hz
1280 x 1024	60Hz	60Hz
1280 x 720	60Hz	60Hz
1600 x 900	60Hz	60Hz
1920 x 1080	60Hz	60Hz

Resolution	DisplayPort Refresh rate	HDMI Refresh rate
1280 x 960	240Hz	240Hz
1024 x 768	240Hz	240Hz
1728 x 1080	240Hz	240Hz
1440 x 1080	240Hz	240Hz
1152 x 864	240Hz	240Hz
1280 x 960	260Hz*	-
1024 x 768	260Hz*	-
1152 x 864	260Hz*	-
1728 x 1080	260Hz*	-
1440 x 1080	260Hz*	-
1280 x 960	280Hz*	-
1024 x 768	280Hz*	-
1152 x 864	280Hz*	-
1728 x 1080	280Hz*	-
1440 x 1080	280Hz*	-

***Only supported when Overclocking is activated.**

Video Timing

Resolution	DisplayPort Refresh rate	HDMI Refresh rate
640 x 480p	59.94/60Hz	59.94/60Hz
720 x 480p	59.94/60Hz	59.94/60Hz
720 x 576p	50Hz	50Hz
1280 x 720p	50Hz	50Hz
1280 x 720p	59.94/60Hz	59.94/60Hz
1920 x 1080p	23.98/24Hz	23.98/24Hz
1920 x 1080p	25Hz	25Hz
1920 x 1080p	29.97/30Hz	29.97/30Hz
1920 x 1080p	50Hz	50Hz
1920 x 1080p	59.94/60Hz	59.94/60Hz
1920 x 1080p	119.88/120Hz	119.88/120Hz
1920 x 1080p	100Hz	100Hz
3840 x 2160p	-	50Hz
3840 x 2160p	-	59.94/60Hz

